

**Han® PCB-adapter**

Page

Technical characteristics Han DD® with PCB-adapter . . . . .	<b>20.02</b>
Han DD® with PCB-adapter . . . . .	<b>20.03</b>
Technical characteristics Han E® with PCB-adapter . . . . .	<b>20.04</b>
Han E® with PCB-adapter . . . . .	<b>20.05</b>
Technical characteristics Han® Q 4/2 with PCB-adapter . . . . .	<b>20.06</b>
Han® Q 4/2 with PCB-adapter . . . . .	<b>20.07</b>
Technical characteristics Han® Q 5/0 with PCB-adapter . . . . .	<b>20.08</b>
Han® Q 5/0 with PCB-adapter . . . . .	<b>20.09</b>
Technical characteristics Han® Q 7/0 with PCB-adapter . . . . .	<b>20.10</b>
Han® Q 7/0 with PCB-adapter . . . . .	<b>20.11</b>
Technical characteristics Han® Q 8/0 with PCB-adapter . . . . .	<b>20.12</b>
Han® Q 8/0 with PCB-adapter . . . . .	<b>20.13</b>
Technical characteristics Han-Modular® with PCB-adapter . . . . .	<b>20.14</b>
Han-Modular® with PCB-adapter . . . . .	<b>20.15</b>
Applications . . . . .	<b>20.16</b>

## Features

- ❑ Robust design
- ❑ Suitable for standard and EMC housing
- ❑ Low wiring costs
- ❑ Higher contact density

## Technical characteristics

### Approvals



### Inserts

Number of contacts 24, 42, 72, 108

Electrical data  
acc. to DIN VDE 0627

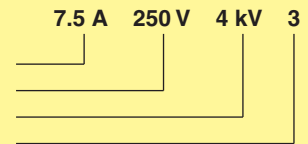

Working current  
Working voltage  
Rated impulse voltage  
Pollution degree

Working voltage  
acc. to UL

250 V

Testing voltage  $U_{rms}$   
Insulation resistance

2 kV  
 $\geq 10^{10} \Omega$

Material

Polyamide

Limiting temperatures

- 40 °C / +125 °C

Flammability acc. to UL 94

HB

Mechanical working life

$\geq 500$

- Mating cycles

Wire gauge

0.14 - 2.5 mm<sup>2</sup>

## Layout of printed circuit boards

Han<sup>®</sup> 24 DD

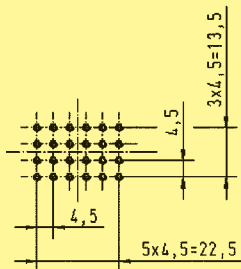

Han<sup>®</sup> 42 DD

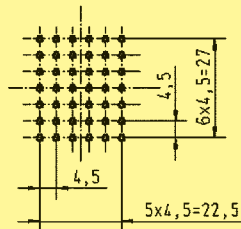

Han<sup>®</sup> 72 DD

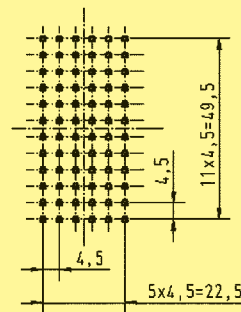

Han<sup>®</sup> 108 DD

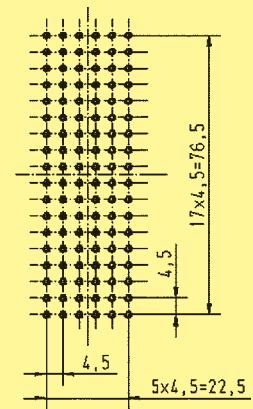

Recommended hole diameter: 0.8 mm

## Assembly situation

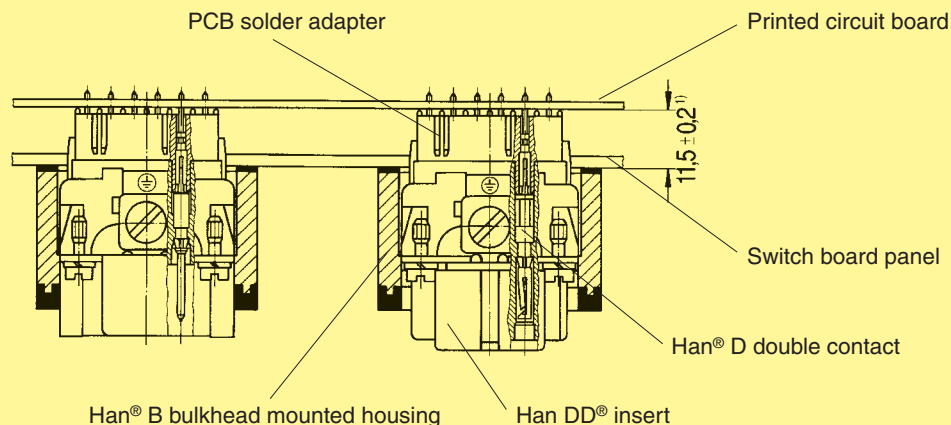

<sup>1)</sup> for Han<sup>®</sup> B EMC hoods/housings spacing of  $12.5 \pm 0.2$  is necessary as no flange seal is used.

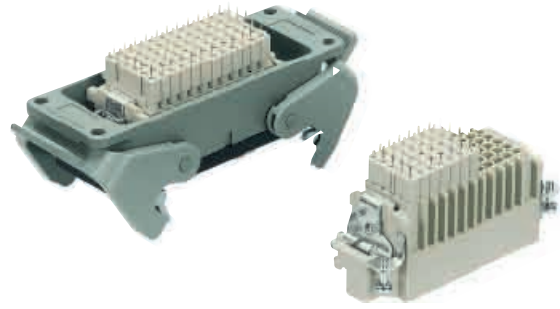

Part No.																										
Insert	Size	Male insert (M)	Female insert (F)	Drawing	Dimensions in mm																					
Order contacts separately					1) Distance for contact max. 21 mm																					
Han <sup>®</sup> 24 DD	6 B	<b>09 16 024 3001</b>	<b>09 16 024 3101</b>		a	b																				
Han <sup>®</sup> 42 DD	10 B	<b>09 16 042 3001</b>	<b>09 16 042 3101</b>		44	51																				
Han <sup>®</sup> 72 DD	16 B	<b>09 16 072 3001</b>	<b>09 16 072 3101</b>		57	64																				
Han <sup>®</sup> 108 DD	24 B	<b>09 16 108 3001</b>	<b>09 16 108 3101</b>		77.5	84.5																				
					104	111																				
Part No.																										
Han DD <sup>®</sup> double contacts	Male contacts	Female contacts	Drawing	Dimensions in mm																						
to connect the PCB-adapter																										
	<b>09 15 000 6191</b>	<b>09 15 000 6291</b>																								
Part No.																										
PCB adapter				Drawing	Dimensions in mm																					
for PCBs up to 1.6 mm for PCBs up to 2.4 mm					<table border="1"> <thead> <tr> <th></th> <th>a</th> </tr> </thead> <tbody> <tr> <td>09 16 000 9905</td> <td>2.6</td> </tr> <tr> <td>09 16 000 9908</td> <td>3.4</td> </tr> </tbody> </table>			a	09 16 000 9905	2.6	09 16 000 9908	3.4														
	a																									
09 16 000 9905	2.6																									
09 16 000 9908	3.4																									
Part No.																										
Housing	Size			Drawing	Dimensions in mm																					
					<table border="1"> <thead> <tr> <th>Size</th> <th>a</th> <th>b</th> <th>Panel cut out</th> </tr> </thead> <tbody> <tr> <td>6 B</td> <td>70</td> <td>80</td> <td>48 x 35</td> </tr> <tr> <td>10 B</td> <td>83</td> <td>93</td> <td>60 x 35</td> </tr> <tr> <td>16 B</td> <td>103</td> <td>113</td> <td>82 x 35</td> </tr> <tr> <td>24 B</td> <td>130</td> <td>140</td> <td>108 x 35</td> </tr> </tbody> </table> Size 6 B with 1 locking lever		Size	a	b	Panel cut out	6 B	70	80	48 x 35	10 B	83	93	60 x 35	16 B	103	113	82 x 35	24 B	130	140	108 x 35
Size	a	b	Panel cut out																							
6 B	70	80	48 x 35																							
10 B	83	93	60 x 35																							
16 B	103	113	82 x 35																							
24 B	130	140	108 x 35																							
	6 B	<b>09 30 006 0301</b>																								
	10 B	<b>09 30 010 0301</b>																								
	16 B	<b>09 30 016 0301</b>																								
	24 B	<b>09 30 024 0301</b>																								
Part No.																										
Further informations see chapter DD																										

Device side

Cable side

PCB-Adapter

## Features

- ❑ Robust design
- ❑ Suitable for standard and EMC housings
- ❑ Low wiring costs
- ❑ Counter connector available with screw, crimp or cage clamp termination

## Technical characteristics

### Inserts

Number of contacts 6, 10, 16, 24

Electrical data  
acc. to DIN EN 61 984

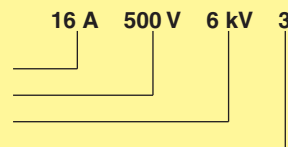

Working current  
Working voltage  
Rated impulse voltage  
Pollution degree

Insulation resistance  
Material  
Limiting temperatures  
Flammability acc. to UL 94  
Mechanical working life  
- Mating cycles  
Wire gauge

$\geq 10^{10} \Omega$   
Polycarbonate  
- 40 °C / +125 °C  
V 0  
 $\geq 500$   
0.5 - 4 mm<sup>2</sup>

## Layout of printed circuit boards

Han<sup>®</sup> 6 E

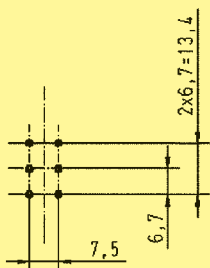

Han<sup>®</sup> 10 E

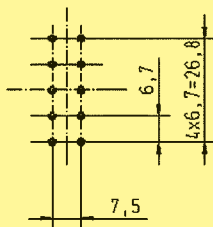

Han<sup>®</sup> 16 E

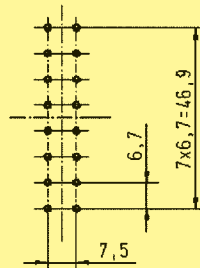

Han<sup>®</sup> 24 E

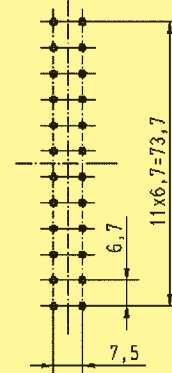

Recommended hole diameter: 1.8 mm

## Assembly situation

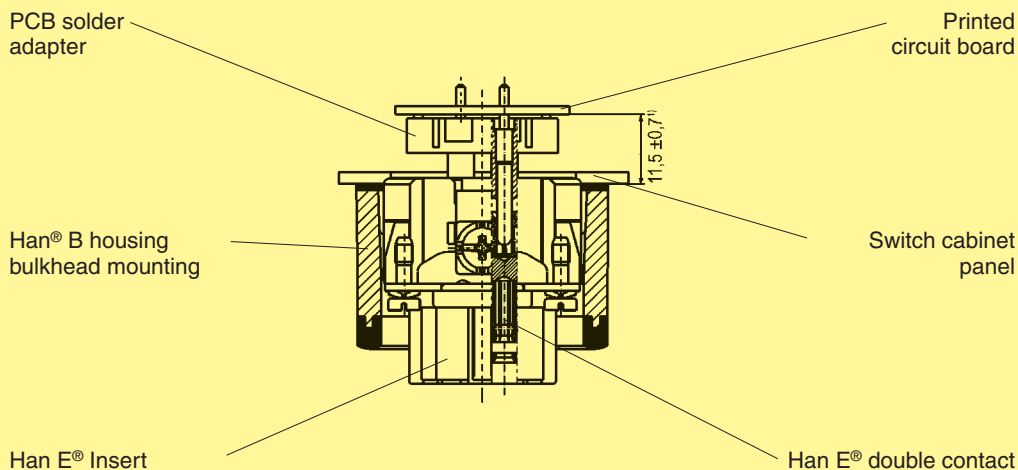

<sup>1)</sup> for Han<sup>®</sup> B EMC hoods/housings spacing of 12.5 ± 0.7 is necessary as no flange seal is used

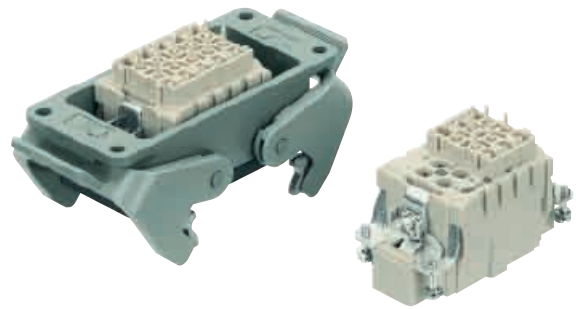

Inserts	Size	Part No.		Drawing	Dimensions in mm															
		Male insert (M)	Female insert (F)																	
Order contacts separately					<p>1) Distance for contact max. 21 mm</p> <table border="1"> <thead> <tr> <th></th> <th>a</th> <th>b</th> </tr> </thead> <tbody> <tr> <td>6 E</td> <td>44</td> <td>51</td> </tr> <tr> <td>10 E</td> <td>57</td> <td>64</td> </tr> <tr> <td>16 E</td> <td>77.5</td> <td>84.5</td> </tr> <tr> <td>24 E</td> <td>104</td> <td>111</td> </tr> </tbody> </table>		a	b	6 E	44	51	10 E	57	64	16 E	77.5	84.5	24 E	104	111
	a	b																		
6 E	44	51																		
10 E	57	64																		
16 E	77.5	84.5																		
24 E	104	111																		
Han® 6 E	6 B	<b>09 33 006 2602</b>	<b>09 33 006 2702</b>																	
Han® 10 E	10 B	<b>09 33 010 2602</b>	<b>09 33 010 2702</b>																	
Han® 16 E	16 B	<b>09 33 016 2602</b>	<b>09 33 016 2702</b>																	
Han® 24 E	24 B	<b>09 33 024 2602</b>	<b>09 33 024 2702</b>																	

Han E® double contacts to connect the PCB-adapter	Part No.		Drawing	Dimensions in mm
	Male contacts	Female contacts		
	<b>09 33 000 6180</b>	<b>09 33 000 6280</b>		

PCB adapter	Part No.		Drawing	Dimensions in mm
	Male contacts	Female contacts		
	<b>09 33 000 9996</b>			

Housing	Size	Part No.		Drawing	Dimensions in mm																				
		Male insert (M)	Female insert (F)																						
	6 B 10 B 16 B 24 B	<b>09 30 006 0301</b> <b>09 30 010 0301</b> <b>09 30 016 0301</b> <b>09 30 024 0301</b>			<table border="1"> <thead> <tr> <th>Size</th> <th>a</th> <th>b</th> <th>Panel cut out</th> </tr> </thead> <tbody> <tr> <td>6 B</td> <td>70</td> <td>80</td> <td>48 x 35</td> </tr> <tr> <td>10 B</td> <td>83</td> <td>93</td> <td>60 x 35</td> </tr> <tr> <td>16 B</td> <td>103</td> <td>113</td> <td>82 x 35</td> </tr> <tr> <td>24 B</td> <td>130</td> <td>140</td> <td>108 x 35</td> </tr> </tbody> </table> <p>Size 6 B with 1 locking lever</p>	Size	a	b	Panel cut out	6 B	70	80	48 x 35	10 B	83	93	60 x 35	16 B	103	113	82 x 35	24 B	130	140	108 x 35
Size	a	b	Panel cut out																						
6 B	70	80	48 x 35																						
10 B	83	93	60 x 35																						
16 B	103	113	82 x 35																						
24 B	130	140	108 x 35																						

Further informations see chapter E

Device side

Cable side

PCB-Adapter

## Features

- ❑ Robust Design
- ❑ Suitable for Han-Compact® hoods and housings
- ❑ Low wiring costs
- ❑ High contact density

## Technical characteristics

Approvals	
Number of contacts	4/2 + PE
<b>Electrical data acc. to DIN EN 61 984</b>	
Power area	30 A 400/690 V 6 kV 2
Rated current	30 A
Rated voltage	
conductor - ground	400 V
conductor - conductor	690 V
Rated impulse voltage	6 kV
Pollution degree	2
Signal area	7.5 A 250 V 4 kV 2
Rated current	7.5 A
Rated voltage	250 V
Rated impulse voltage	4 kV
Pollution degree	2
Insulation resistance	$\geq 10^{10} \Omega$
Material	LCP
Limiting temperatures	-40 °C ... +125 °C
Flammability acc. to UL 94	V 0
Mechanical working life	$\geq 500$ mating cycles

## Layout of printed circuit boards

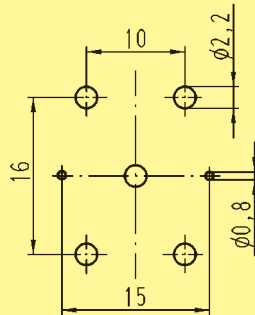

## Assembly situation

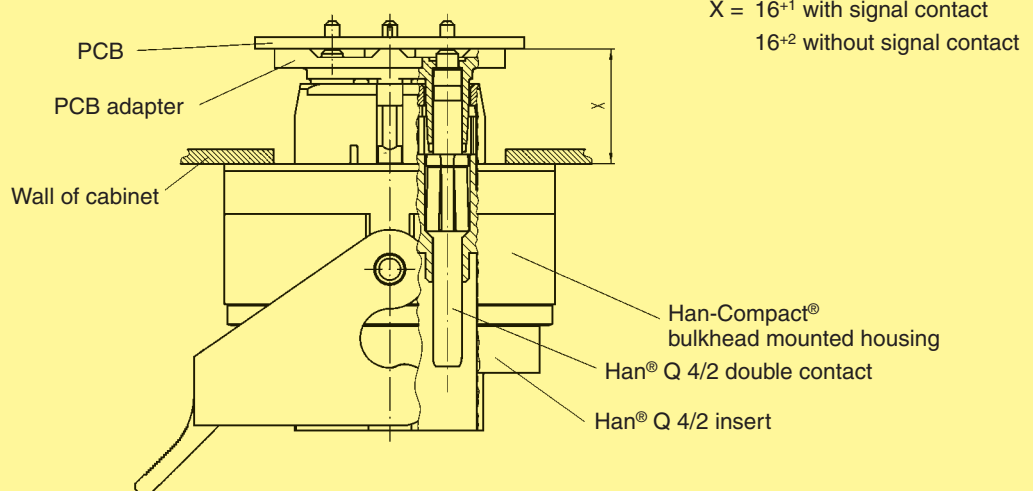





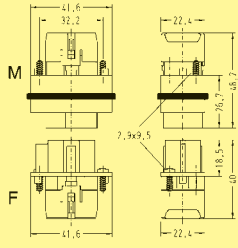
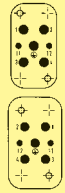

Device side

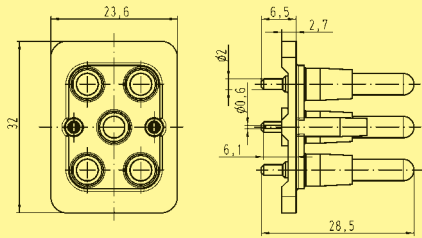
Cable side

Insert	Part No.		Drawing	Dimensions in mm
	Male insert (M)	Female insert (F)		
Order contacts separately 	<b>09 12 006 3041</b>	<b>09 12 006 3141</b>		<b>Contact arrangement</b> View from termination side 

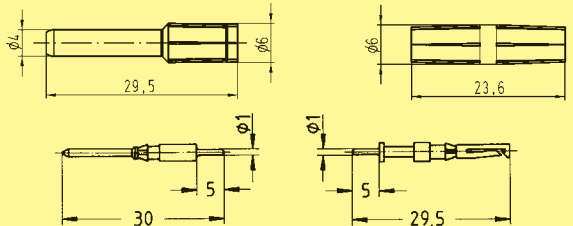
PCB-adapter	Part No.	Drawing	Dimensions in mm
for PCBs up to 2.4 mm 	<b>09 12 006 9901</b>		

Han® Q 4/2 double contacts	Part No.		Drawing	Dimensions in mm
	Male contact	Female contact		
to connect the PCB adapter Power contact 	<b>09 32 000 6180</b>	<b>09 32 000 6280</b>		
Signal contact 	<b>09 15 000 6191</b>	<b>09 15 000 6293</b>		

PCB-Adapter

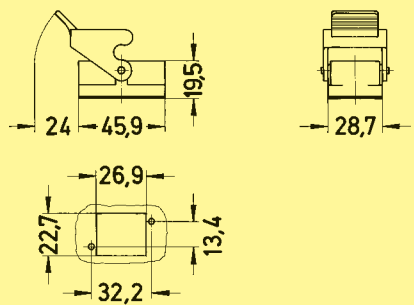
Housing	bulkead mounting	Part No.	Drawing	Dimensions in mm
Plastic		<b>09 12 008 0327</b>	Panel cut out 	

Further informations see chapter Q

## Features

- ❑ Robust design
- ❑ Suitable for EMC housings
- ❑ Low wiring costs
- ❑ Additional robust and secure PE-connection between housing and PCB

## Technical characteristics

### Approvals



### Inserts

Number of contacts 5

Electrical data  
acc. to DIN EN 61 984

	10 A	230/400 V	4 kV	3
Working current	_____			
Working voltage conductor – ground	_____			
Working voltage conductor – conductor	_____			
Rated impulse voltage	_____			
Pollution degree	_____			

- pollution degree 2 also 10 A 320/500 V 4 kV 2

Working voltage  
acc. to UL/CSA 400 V

Insulation resistance  $\geq 10^{10} \Omega$   
 Material Polycarbonate  
 Limiting temperatures  $-40^{\circ}\text{C} \dots +125^{\circ}\text{C}$   
 Flammability acc. to UL 94 V 0  
 Mechanical working life  
 - Mating cycles  $\geq 500$

## Layout of printed circuit boards

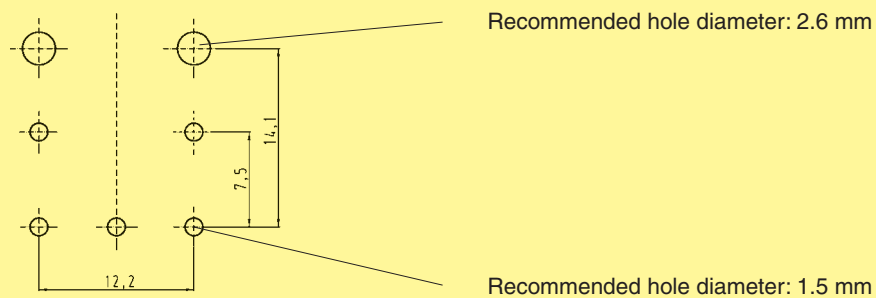

## Assembly situation

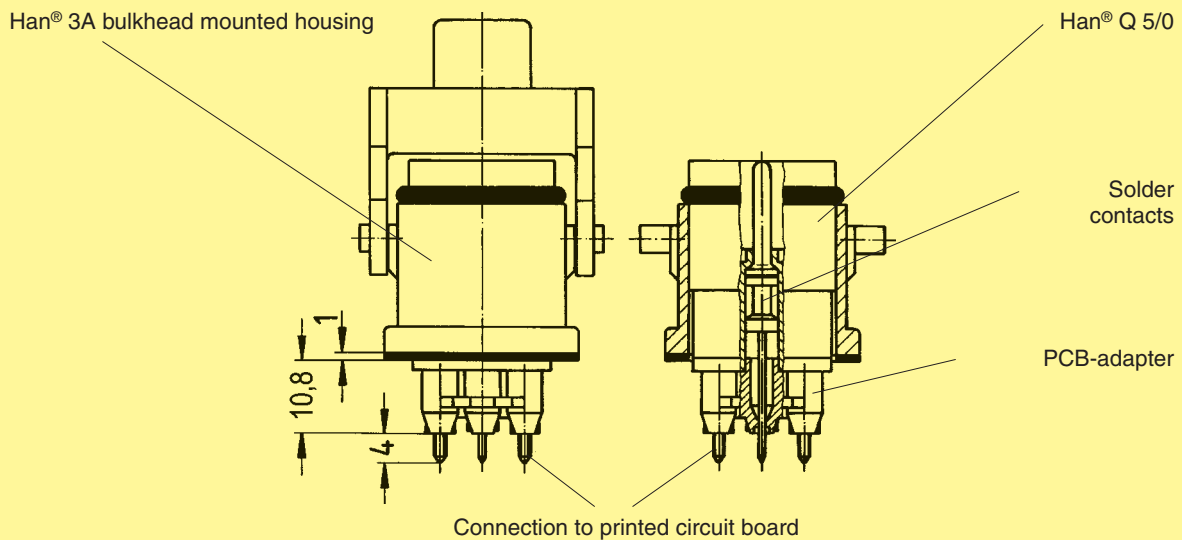

PCB-Adapter





Device side	Insert		Part No.		Drawing	Dimensions in mm
	Male insert (M)	Female insert (F)				
	Order contacts separately		<b>09 12 005 3001</b>	<b>09 12 005 3101</b>	<p>1) Distance for contact max. 21 mm</p>	
	PCB-adapter		Part No.		Drawing	Dimensions in mm
	with PE contact panel for Han® Q 5/0		<b>09 12 000 9905</b>		<p>Adapter PE contact panel</p>	
	Solder contacts		Part No.		Drawing	Dimensions in mm
	to connect the PCB-adapter		Male contact	Female contact		
			<b>09 33 000 6195</b>	<b>09 33 000 6295</b>		
	Housing bulhead mounting		Part No.		Drawing	Dimensions in mm
			<b>09 62 003 0304</b>		<p>Panel cut out 22 x 22 mm</p>	
Cable side	Further informations see chapter Q					

PCB-Adapter

## Features

- ❑ Robust design
- ❑ Suitable for standard and EMC housings
- ❑ Low cost wiring
- ❑ High contact density

## Technical characteristics

### Approvals



### Inserts

Number of contacts 7

Electrical data  
acc. to DIN EN 61 984

7.5 A 250 V 4 kV 3

Working current  
Working voltage  
Rated impulse voltage  
Pollution degree

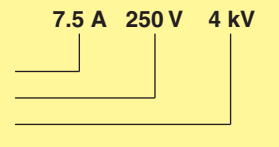

Insulation resistance  
Material  
Limiting temperatures  
Flammability acc. to UL 94  
Mechanical working life  
- Mating cycles

$\geq 10^{10} \Omega$   
Polycarbonate  
- 40 °C ... +125 °C  
V 0  
 $\geq 500$

## Layout of printed circuit boards

Recommended hole diameter: 0.8 mm

Dimensions in mm

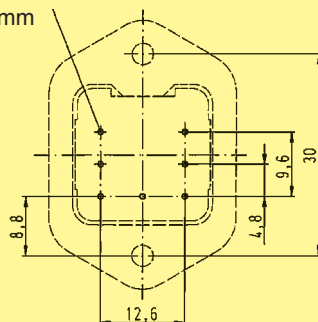

## Assembly situation

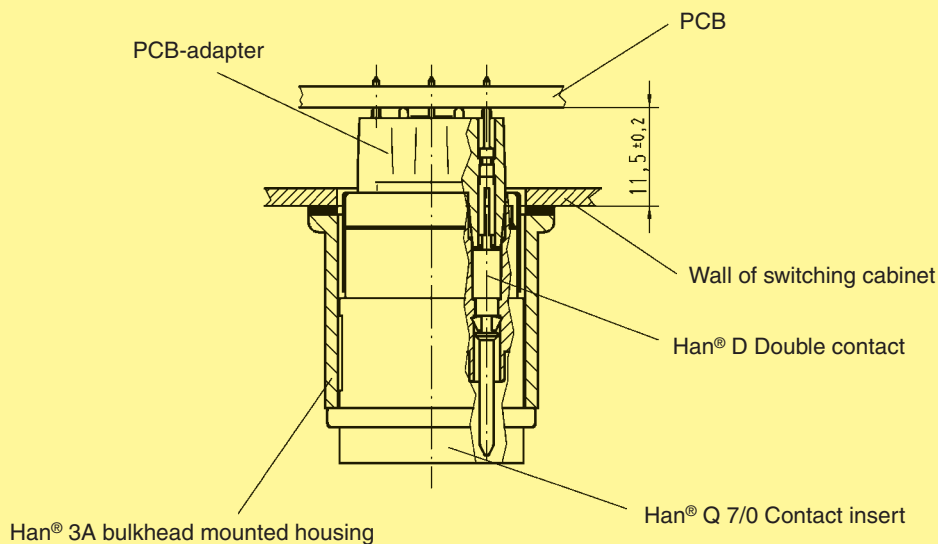



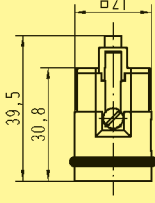
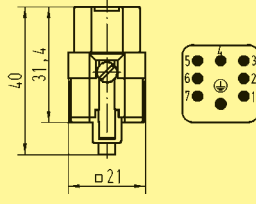

Device side

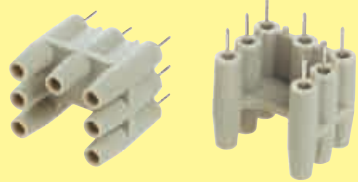
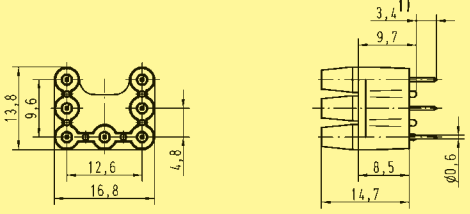
Insert	Part No.		Drawing	Dimensions in mm
	Male insert (M)	Female insert (F)		
Order contacts separately				
	<b>09 12 007 3001</b>	<b>09 12 007 3101</b>		
Coding	<b>09 12 000 9901</b>	<b>09 12 000 9902</b>		

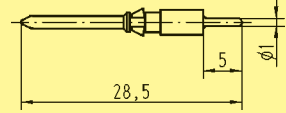
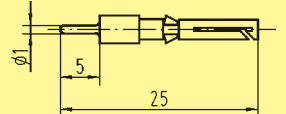
PCB-adapter	Part No.	Drawing	Dimensions in mm
for PCB up to 2.4 mm			
	<b>09 12 000 9908</b>		

Solder contacts	Part No.		Drawing	Dimensions in mm
	Male contact	Female contact		
to connect the PCB-adapter				
	<b>09 15 000 6190</b>	<b>09 15 000 6290</b>		
				

PCB-Adapter

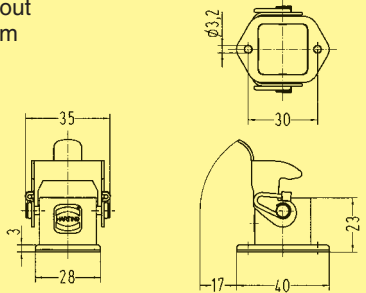
Housing	bulkead mounting	Part No.	Drawing	Dimensions in mm
		<b>09 20 003 0301</b>	Panel cut out 22 x 22 mm	

Cable side

Further informations see chapter Q

## Features

- ❑ Robust Design
- ❑ Suitable for Han-Compact® hoods and housings
- ❑ Low wiring costs
- ❑ High contact density

## Technical characteristics

Approvals	
Number of contacts	8
Electrical data acc. to DIN EN 61 984	16 A 230/400 V 4 kV 2
Rated current	16 A
Rated voltage	
conductor - ground	230 V
conductor - conductor	400 V
Rated impulse voltage	4 kV
Pollution degree	2
Insulation resistance	$\geq 10^{10} \Omega$
Material	LCP
Limiting temperatures	-40 °C ... +125 °C
Flammability acc. to UL 94	V 0
Mechanical working life	$\geq 500$ mating cycles

## Layout of printed circuit boards

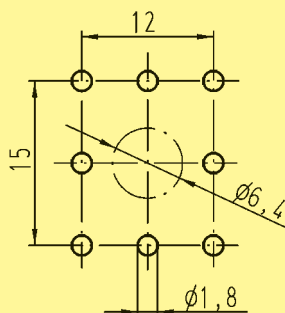

## Assembly situation

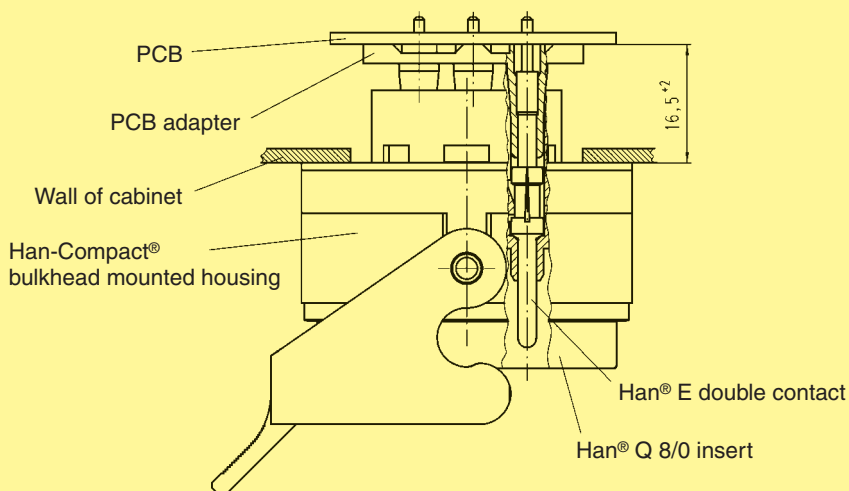



Device side	Insert		Part No.		Drawing	Dimensions in mm
	Male insert (M)	Female insert (F)	Male insert (M)	Female insert (F)		
	Order contacts separately					<b>Contact arrangement</b> View from termination side 
			<b>09 12 008 3001</b>	<b>09 12 008 3101</b>		
	PCB-adapter					
	for PCBs up to 1.6 mm					
			<b>09 12 008 9901</b>			
	Han® Q 8/0 double contacts					
	to connect the PCB adapter					
			<b>09 33 000 6180</b>	<b>09 33 000 6280</b>		
	Housing bulhead mounting					
	Plastic					
			<b>09 12 008 0327</b>			
Cable side	Further informations see chapter Q					

PCB-Adapter

## Features

- ❑ Modular assembly
- ❑ Robust design
- ❑ Suitable for standard and EMC housings
- ❑ Low wiring costs

## Technical characteristics

### Han DD® module with PCB-adapter

Number of contacts	12
Working current	7.5 A
Working voltage	250 V
Wire gauge	0.14 - 2.5 mm <sup>2</sup>

### Han® axial screw module for PCB adaptations

Number of contacts	2
Working current	40 A
Working voltage	500 V
Wire gauge	2.5 - 10 mm <sup>2</sup>

## Layout of printed circuit boards

Depiction

Recommended hole diameter: 0,8 mm

Recommended hole diameter: 3,2 mm

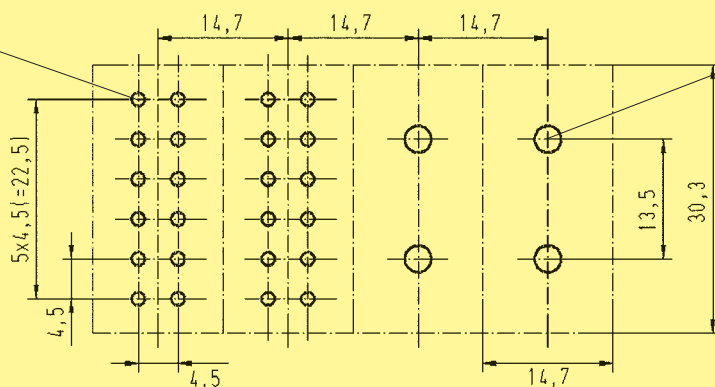

Han DD® module

Han® axial screw module 40 A

PCB-Adapter

## Assembly situation

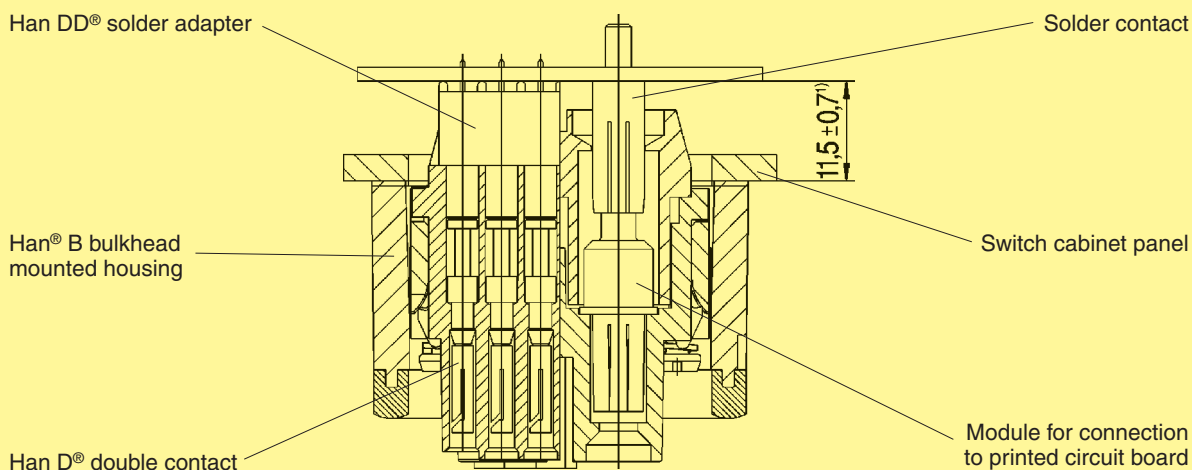

<sup>1)</sup> for Han® B EMC hoods/housings spacing of 12.5 ± 0.7 is necessary as no flange seal is used

Hinged frame	No. of modules	Part No.		Size	Figure
		Male insert (M)	Female insert (F)		
	1	<b>09 14 000 0304</b>	<b>09 14 000 0304</b>	10 A	Drawings and further details see chapter 06
	2	<b>09 14 006 0303</b>	<b>09 14 006 0313</b>	6 B	
	3	<b>09 14 010 0303</b>	<b>09 14 010 0313</b>	10 B	
	4	<b>09 14 016 0303</b>	<b>09 14 016 0313</b>	16 B	
	5	<b>09 14 024 0303</b>	<b>09 14 024 0313</b>	24 B	
	6	<b>09 14 024 0303</b>	<b>09 14 024 0313</b>	24 B	

Identification	Part No.		Drawing	Dimensions in mm						
	Male insert (M)	Female insert (F)								
<b>Han DD® module</b> PCB termination/ crimp termination 	<b>09 14 012 3001</b>	<b>09 14 012 3101</b>								
<b>Han D® double contacts</b> to connect the PCB 	<b>09 15 000 6191</b>	<b>09 15 000 6291</b>								
<b>PCB adapter</b> for PCBs up to 1.6 mm for PCBs up to 2.4 mm 	<b>09 16 000 9905</b> <b>09 16 000 9908</b>			<table border="1"> <thead> <tr> <th></th> <th>a</th> </tr> </thead> <tbody> <tr> <td>09 16 000 9905</td> <td>2.6</td> </tr> <tr> <td>09 16 000 9908</td> <td>3.4</td> </tr> </tbody> </table>		a	09 16 000 9905	2.6	09 16 000 9908	3.4
	a									
09 16 000 9905	2.6									
09 16 000 9908	3.4									

Han® axial screw module	Part No.		Drawing	Dimensions in mm
	Male insert (M)	Female insert (F)		
<b>Axial screw termination</b> Cable side 	<b>09 14 002 2601</b>	<b>09 14 002 2701</b>		
<b>PCB adaption</b> Device side 	<b>09 14 002 2603</b>	<b>09 14 002 2703</b>		
<b>Solder contact</b> 	<b>09 32 000 6295</b>			

PCB-Adapter

- Secondary mating between industrial connector and printed circuit board.
- No higher force is applied on the soldering joint when mating the industrial connector due to an additional mating point.
- No wiring between printed circuit board and industrial connector necessary.
- thus no wiring faults  
⇒ no testing, no costs
- Connecting times are minimized.
- Easy handling is time and cost saving.
- The production of mechanical and electrical / electronical components can be completely separated.
- Possibility to reach a higher degree of automation in the production (i. e. wave soldering of the PCBs).

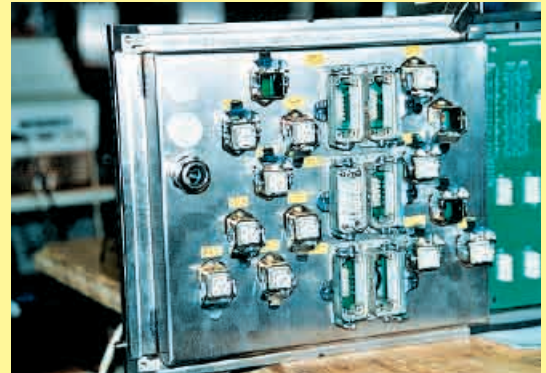

Han DD® and Han® Q 5/0 PCB-adapter  
Wilhelm Fette GmbH, Germany

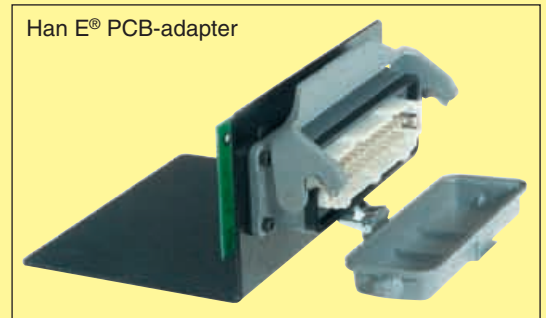

Han E® PCB-adapter

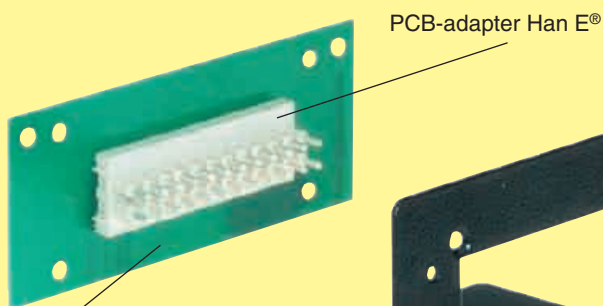

PCB-adapter Han E®

Printed circuit board

Switch cabinet panel



Han E® connector in a bulkhead mounted housing