

## Contents

	Page
Han-Brid® Features .....	<b>19.02</b>
Han-Brid® Data interfaces .....	<b>19.03</b>
Han-Brid® Overview .....	<b>19.04</b>
Han-Brid® Cu .....	<b>19.06</b>
Han-Brid® F.O. ....	<b>19.08</b>
Han-Brid® Quintax 3 A .....	<b>19.10</b>
Han-Brid® RJ45 C .....	<b>19.12</b>
Han-Brid® USB / Han-Brid® FireWire .....	<b>19.14</b>
Han® 4 A SC .....	<b>19.16</b>
Han-Brid® Hoods/Housings .....	<b>19.18</b>

## Features

### General Description

The Han-Brid® series allows the connection of a data interface and a power supply in a single space saving connector. This means that it is now possible to provide data transmission and power to devices in a single bus structure. This hybrid connector family includes provision for connection of a max. 50 V, 10 A power supply together with a range of inserts for connection of a variety of data protocols and transmission medias:

- Han-Brid® F.O. for plastic (POF) or for HCS®\* optical fibre
- Han-Brid® Cu for shielded twisted pair
- Han-Brid® Quintax 3 A for Coax cable with large diameter
- Han-Brid® Quintax 3 A for shielded 4 or 8 wire bus systems (2 pair STP)
- Han-Brid® RJ45 C for Ethernet application
- Han-Brid® USB / Firewire for fast data transmission

Han-Brid® inserts fit into the standard plastic as well as metal hoods and housings with seal of the Han® 3 A series offering a degree of protection IP 65 according to DIN EN 60 529. For harsher environments Han® 3 HPR hoods and housings with a degree of protection of IP 68 can be used.

## Power supply

- Han D® male and female with standard crimp contacts (Order crimp contacts separately)
- Rated current 10 A
- Rated voltage 50 V
- termination side 0.14 - 2.5 mm<sup>2</sup>
- Approval 

## Data interfaces

### Han-Brid® F.O.

- Is suitable for all HP Versatile Link (Horizontal Package) transmitters and receivers
- Data rates: Standard 12 Mbit/s, suitable for all common fieldbus systems
- Insert allows integration of HP standard contacts for POF and HCS®\* fibres
- Temperature range            -40 °C ... +70 °C

### Han-Brid® Cu

- For termination of a shielded twisted pair
- Insert for 2x Han D® male or female contacts
- Connection of the shield by means of shielding plate and fixing clamps
- Connection of the device side can be realized either by a printed circuit board as a modular version or as part of the appliance PCB
- Insert for bulkhead mounted housing or the coupling housing are always equipped with a screening spring

### Bus Terminator

- Active bus terminator in male and female version
- Standard Han® 3 A hoods and housings
- Power supply to the termination network via electrical contacts of Han-Brid®
- Integrated, galvanically separated DC/DC converter 24 V / 5 V

### Han-Brid® Quintax 3 A

- Possibility to terminate shielded four/eight wires conductors (2 pair STP)
- Possibility to terminate Coax cable with large diameter
- Suitable for all 4-wire bus systems
- Suitable for shielded cable conductor diameter 3 – 9.5 mm
- Transmission of shielding separately from the hood's ground
- Connections are carried out acc. to DIN EN 50 173, Cat. 5
- Temperature range            -40 °C ... +70 °C

### Han-Brid® RJ45 C

- Suitable for standard RJ 45 Plug and Jack, shielded version
- Connections provided for conductors acc. to DIN EN 50 173, Cat. 5
- Termination from the device side is carried out via a PCB, two versions are possible: modular version or as part of the appliance PCB
- Assembly with standard tools
- Insert for 2 Han-D® male or female contacts offers the combination with electrical bus connector
- Rated current                    10 A
- Rated voltage                    24 V
- termination side                0.14 - 2.5 mm²

### Han-Brid® USB

- Insert for all Han® 3 A hoods and housings
- Hood with glued sealing
- Simple and low-cost termination via insert of a patch cable
- Strain-relief via cable tie

### Han-Brid® FireWire

- Insert for all Han® 3 A hoods and housings
- Hood with glued sealing
- Simple and low-cost termination via insert of a patch cable
- Strain-relief via cable tie
- Compatible to IEEE 1394

### Han® 4 A SC

- Suitable with housings, size Han® 3 A including versions Han® M, Han® EMV and Han® HPR
- Degree of protection up to IP 68
- For fibre optic SC contacts; up to 4 SC contacts per connector
- For 1 mm POF
- For Multimode fibre 50 - 62.5 / 125 µm and Single-mode fibre 9 / 125 µm
- Full ceramic sleeves for a minimal insertion loss

## Overview (Sample: Han-Brid® Cu)

Thermoplastic  
 09 20 003 0320 (light grey)  
 09 20 003 0327 (black)

Metal  
 09 20 003 0301

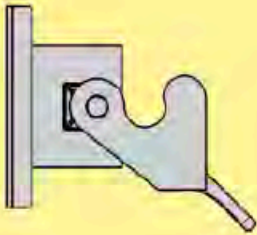

Device side  
 09 12 006 2611  
 09 12 006 2695  
 09 12 006 2694

Cable side  
 09 12 006 3111

Thermoplastic  
 09 20 003 0423 (light grey)  
 09 20 003 0426 (black)  
 19 20 003 0423 (light grey)  
 19 20 003 0426 (black)

Metal  
 09 20 003 1443  
 19 20 003 1443

Thermoplastic  
 09 20 003 0720 (light grey)  
 09 20 003 0727 (black)  
 19 20 003 0720 (light grey)  
 19 20 003 0727 (black)

Metal  
 09 20 003 1750  
 19 20 003 1750

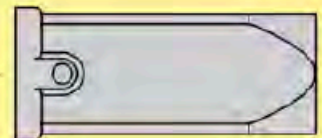
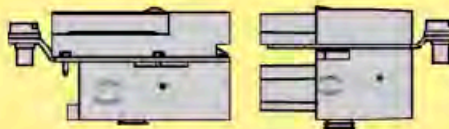
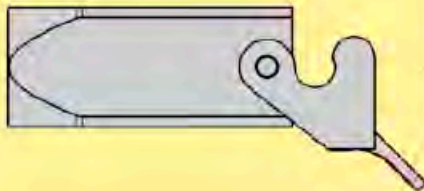

Device side  
 09 12 006 2701  
 09 12 006 2795  
 09 12 006 2794

Cable side  
 09 12 006 3001

Thermoplastic  
 09 20 003 0623 (light grey)  
 09 20 003 0626 (black)  
 19 20 003 0623 (light grey)  
 19 20 003 0627 (black)

Metal  
 09 20 003 1643  
 19 20 003 1643

Thermoplastic  
 09 20 003 0220 (light grey)  
 09 20 003 0227 (black)  
 19 20 003 0220 (light grey)  
 19 20 003 0227 (black)

Metal  
 09 20 003 1250  
 19 20 003 1250

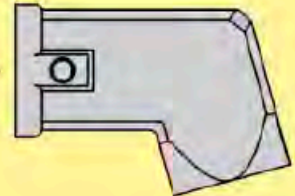
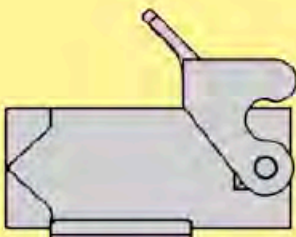

Overview (Sample: Han-Brid® RJ45 C)

Thermoplastic  
 09 20 003 0320 (light grey)  
 09 20 003 0327 (black)

Metal  
 09 20 003 0301

Device side  
 09 12 003 2770  
 09 12 003 2774  
 09 12 003 2776

Cable side  
 09 12 003 3011  
 09 12 003 3021  
 09 12 003 3031

Thermoplastic  
 09 20 003 0423 (light grey)  
 09 20 003 0426 (black)  
 19 20 003 0423 (light grey)  
 19 20 003 0427 (black)

Metal  
 09 20 003 1443  
 19 20 003 1443

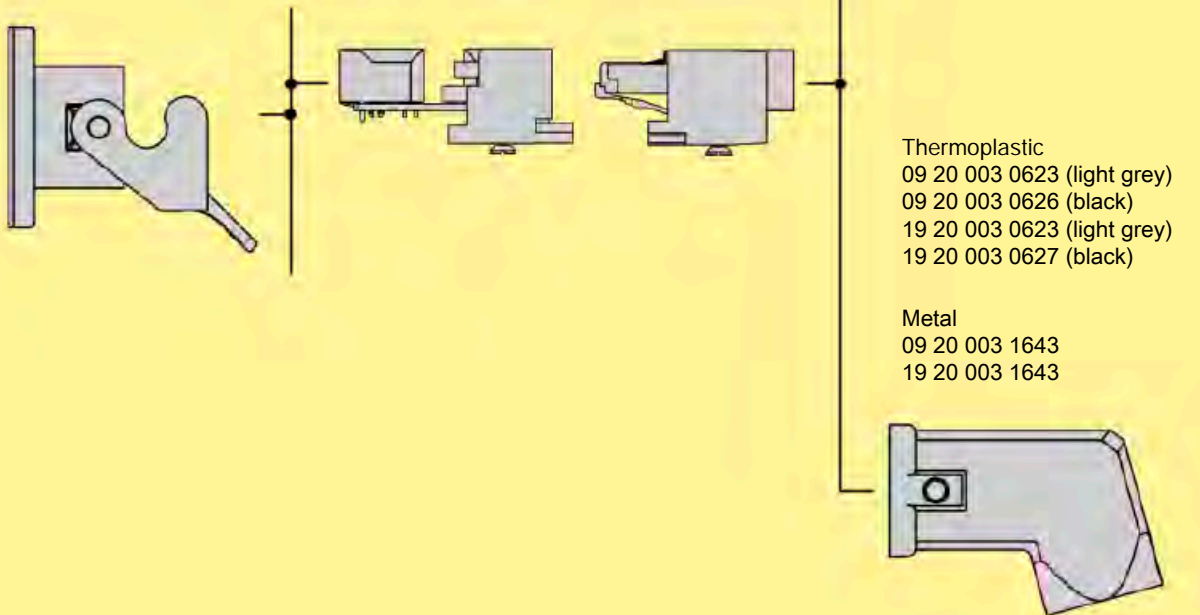





Thermoplastic  
 09 20 003 0623 (light grey)  
 09 20 003 0626 (black)  
 19 20 003 0623 (light grey)  
 19 20 003 0627 (black)

Metal  
 09 20 003 1643  
 19 20 003 1643



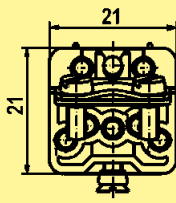
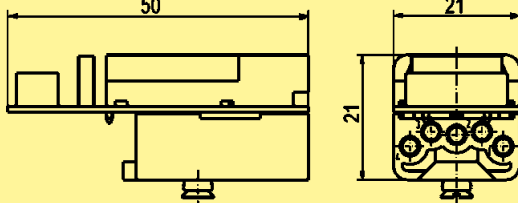
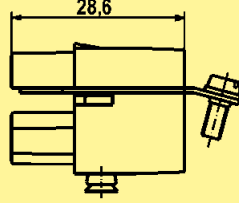
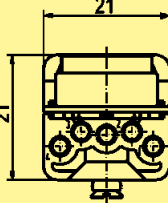

Han-Brid

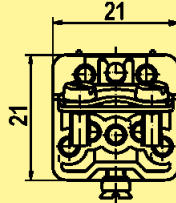
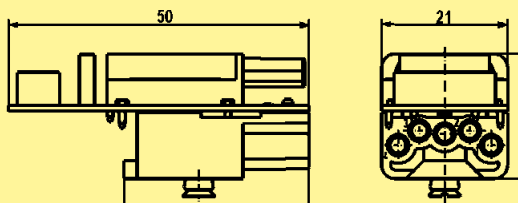
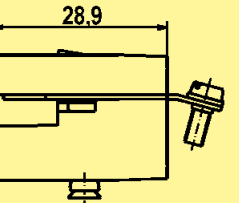
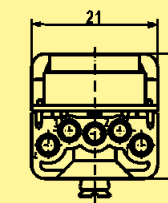
Hybrid field bus connector  
for shielded twisted pair  
+ 4 electrical contacts 10 A  
+ option for PE

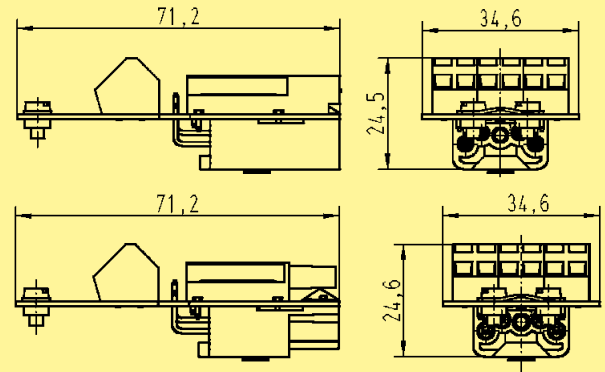
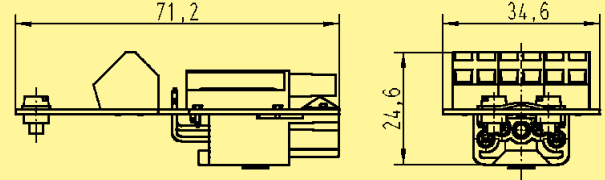

Identification	Part number		Drawing	Dimensions in mm
	Male insert (M)	Female insert (F)		
Cable side Female insert    Device side Male insert  		<b>09 12 006 3111</b>	 view from termination side 	  
Cable side Male insert    Device side Female insert  	09 12 006 2611  Also available as single part  loaded 09 12 002 2611 unloaded 09 12 002 3011 unloaded 09 12 004 3011	<b>09 12 006 3001</b>	 view from termination side 	  

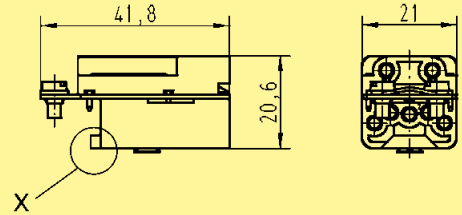
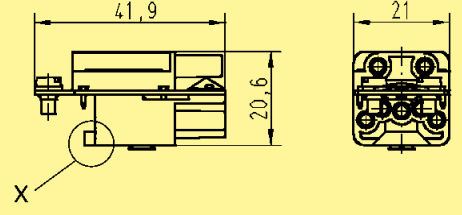
Han-Brid

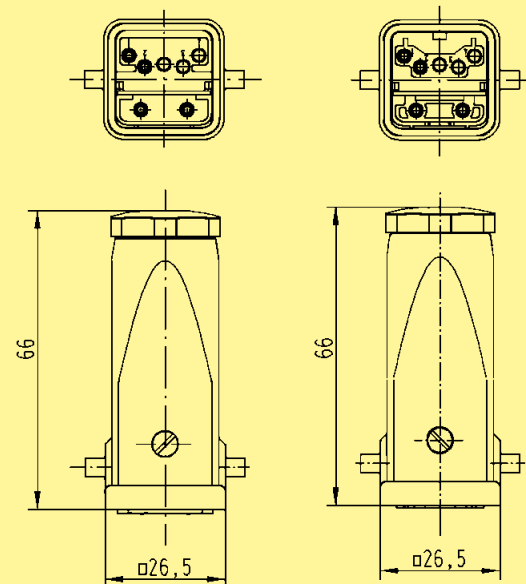
Identification	Part number		Drawing	Dimensions in mm
	Male insert (M)	Female insert (F)		
<p>Panel feed through with cage clamp</p> 	<b>09 12 006 2695</b>			
		<b>09 12 006 2795</b>		
<p>Coupling / Panel feed through</p>  <p>X = Cutting off the fin allows the use in cable to cable housings</p>	<b>09 12 006 2694</b>			
		<b>09 12 006 2794</b>		
<p>Bus terminator</p> <p>Plastic hoods/housings</p>  <p>Hoods/Housings, metal</p> 	<b>09 12 006 2691</b>			
		<b>09 12 006 2791</b>		
	<b>09 12 006 2692</b>			
		<b>09 12 006 2792</b>		

Han-Brid







Hybrid field bus connector  
with F.O. transmitter and receiver  
+ 4 electrical contacts 10 A  
+ option for PE

Identification	Part number		Drawing	Dimensions in mm
	Male insert (M)	Female insert (F)		
Cable side, female F.O. (m) + Han D® (f)			<p>view from termination side</p>	
with F.O. contacts		for POF 09 12 004 2711  for POF crimpless 09 12 004 2713  for HCS®* fibre 09 12 004 2716		
without F.O. contacts		for POF 09 12 004 3111  for POF crimpless 09 12 004 3113  for HCS®* fibre 09 12 004 3116		
Device side, male F.O. (f) + Han D® (m)			<p>view from termination side</p>	
with PCB	09 12 004 2611			
without PCB	09 12 004 3011			

\* HCS®=Hard Clad Silica (is registered trade mark of the SpecTran Corporation)

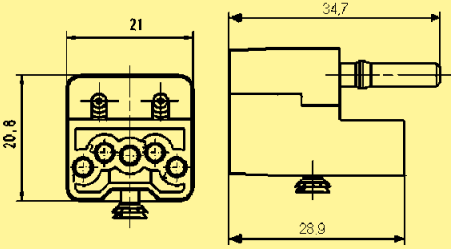

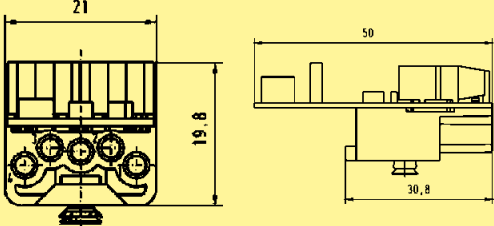
Identification	Part number		Drawing	Dimensions in mm
	Male insert (M)	Female insert (F)		
<p>Cable side, male F.O. (m) + Han D® (m)</p> <p>with F.O. contact</p>  <p>without F.O. contact</p> 	<p>for POF 09 12 004 2601</p> <p>for POF crimpless <b>09 12 004 2603</b></p> <p>for HCS®* fibre 09 12 004 2606</p>		 <p>view from termination side</p>	
<p>Device side, female F.O. (f) + Han D® (f)</p> <p>with PCB</p>  <p>without PCB</p> 		<p>09 12 004 2701</p> <p>09 12 004 3101</p>	 <p>view from termination side</p>	

Han-Brid





\* HCS®=Hard Clad Silica (is registered trade mark of the SpecTran Corporation)

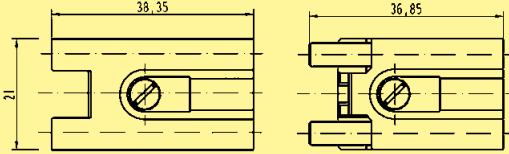

Stock items in bold type

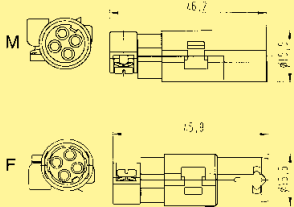

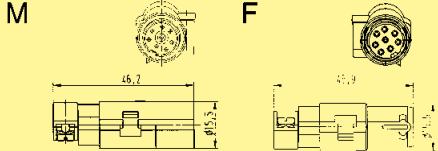
4 contacts + shielding  
 + 2 power contacts  
 suitable in Han® 3 A metric  
 hoods and housings

Identification	Part number		Drawing	Dimensions in mm
	Male insert (M)	Female insert (F)		
Quintax insert 	<b>09 15 003 3001</b>	09 15 003 3101		

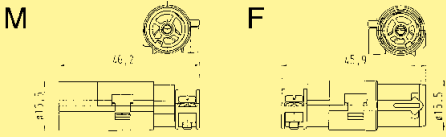
Identification	Wire gauge (mm <sup>2</sup> )	Part number		Drawing	Dimensions in mm
		Male contact	Female contact		
Han-Quintax® contact 4 + shielding Han D® crimp contacts 		<b>09 15 004 3013</b>	<b>09 15 004 3113</b>		
Han D® Crimp contact gold plated 	0,14-0,37 0,5 0,75 1 1,5 2,5	<b>09 15 000 6124</b> <b>09 15 000 6123</b> <b>09 15 000 6125</b> <b>09 15 000 6122</b> <b>09 15 000 6121</b> <b>09 15 000 6126</b>	<b>09 15 000 6224</b> <b>09 15 000 6223</b> <b>09 15 000 6225</b> <b>09 15 000 6222</b> <b>09 15 000 6221</b> <b>09 15 000 6226</b>		
High Density Quintax contact 8 + shielding Han® D-Sub contacts 		<b>09 15 008 3013</b>	<b>09 15 008 3113</b>		
D-Sub crimp contact 	0,08-0,21 0,13-0,33 0,33-0,52	<b>61 03 000 0078</b> <b>61 03 000 0094</b> <b>61 03 000 0073</b>	<b>61 03 000 0080</b> <b>61 03 000 0096</b> <b>61 03 000 0074</b>		

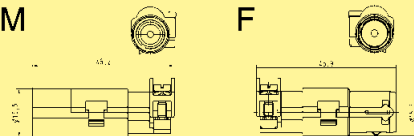
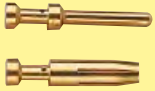
Identification	Wire gauge (mm <sup>2</sup> )	Part number Male contact	Part number Female contact	Drawing	Dimensions in mm
Han D® Coax contact 75 Ω 1 + shielding, 75 Ω Han D® crimp contacts 		<b>09 15 001 3013</b>	<b>09 15 001 3113</b>		
Han D® Crimp contact gold plated 	0,14-0,37 0,5 0,75 1 1,5 2,5	<b>09 15 000 6124</b> <b>09 15 000 6123</b> <b>09 15 000 6125</b> <b>09 15 000 6122</b> <b>09 15 000 6121</b> <b>09 15 000 6126</b>	<b>09 15 000 6224</b> <b>09 15 000 6223</b> <b>09 15 000 6225</b> <b>09 15 000 6222</b> <b>09 15 000 6221</b> <b>09 15 000 6226</b>		
Han E® Coax contact 50 Ω 1 + shielding, 50 Ω Han E® crimp contacts 		<b>09 15 001 3023</b>	<b>09 15 001 3123</b>		
Han E® contacts gold plated 	0,14-0,37 0,5 0,75 1 1,5 2,5 4 5,5	<b>09 33 000 6117</b> <b>09 33 000 6122</b> <b>09 33 000 6115</b> <b>09 33 000 6118</b> <b>09 33 000 6116</b> <b>09 33 000 6123</b> 09 33 000 6119 09 33 000 6139	<b>09 33 000 6217</b> <b>09 33 000 6222</b> <b>09 33 000 6215</b> <b>09 33 000 6218</b> <b>09 33 000 6216</b> <b>09 33 000 6223</b> <b>09 33 000 6221</b> 09 33 000 6239		

Han-Brid

## Assembly instructions

### Quintax-Z-contact

- Strip cable acc. to drawing 1 and fold the shielding over the cable.
- Crimp Han D® contacts onto the wires.

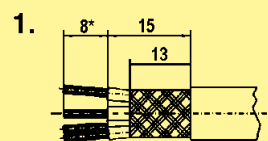



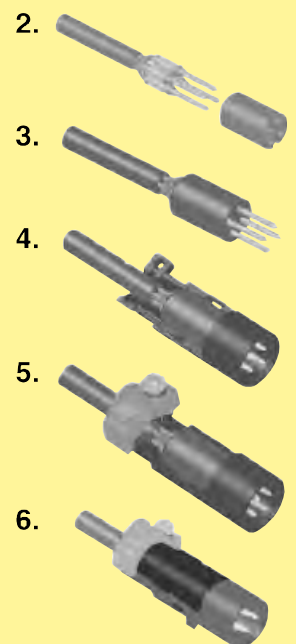



- Insert Han D® contacts into corresponding cavities of insulator until they are snapped in.
- Fit the insert including the cable into the opened shielded bushing. The coding pin of the shielded bushing has to meet the groove of the insulator.
- Clamp the tilt over the shielding onto the cable by means of the special clamp (small opening for cable diameter of 3 - 6 mm, large opening for cable diameter of 6 - 9.5 mm).
- Check the wiring.
- Close the shielded bushing with the cover and insert it into the corresponding cavity of the Quintax Module as usual.



Stock items in bold type



Hybrid network connector  
+ 2 electrical contacts 10 A

Identification	Part number	Drawing	Dimensions in mm
Han-Brid® RJ45 C with RJ Industrial 	<b>09 12 003 3011</b>		
Han-Brid® RJ45 C with Stewart RJ45 	<b>09 12 003 3021</b>		
Han-Brid® RJ45 C with HIROSE RJ45 	<b>09 12 003 3031</b>		
Han-Brid Panel feed through straight 	<b>09 12 003 2774</b>		
Panel feed through angled 	<b>09 12 003 2776</b>		
Panel feed through with 4 pole terminal block 	<b>09 12 003 2770</b>		

Stock items in bold type

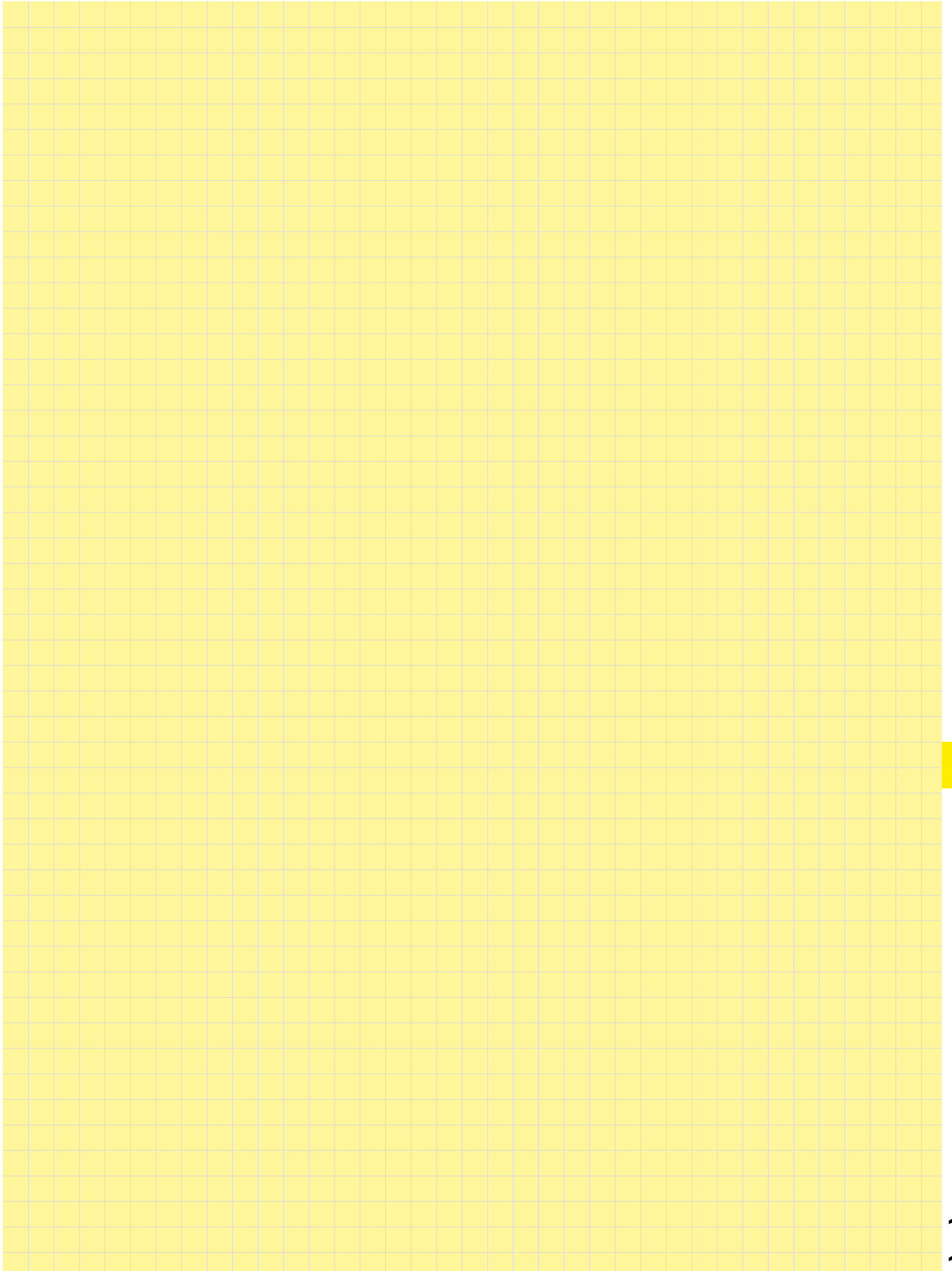

## Han-Brid® USB

### Features

- Insert for all Han® 3 A hoods and housings
- Hood with glued sealing
- Simple and low-cost termination via insert of a patch cable
- Strain-relief via cable tie

### Technical characteristics

USB style A, 2.0 Standard

Specifications	DIN EN 60 664-1 DIN EN 61 984
Number of contacts	4
Electrical data acc. to EN 61 984	<b>1 A 50 V 0.8 kV 3</b>
Rated current	1 A
Rated voltage	50 V
Rated impulse voltage	0.8 kV
Pollution degree	3
Material	polycarbonate
Insulation resistance	≥ 10 <sup>10</sup> Ω
Contact resistance	≥ 4 mΩ
Temperature range	-40 °C ... +85 °C
Flammability acc. to UL 94	V 0
Mechanical working life - mating cycles	≥ 500

## Han-Brid® FireWire

### Features





- Insert for all Han® 3 A hoods and housings
- Hood with glued sealing
- Simple and low-cost termination via insert of a patch cable
- Strain-relief via cable tie
- Compatible to IEEE 1394

### Technical characteristics

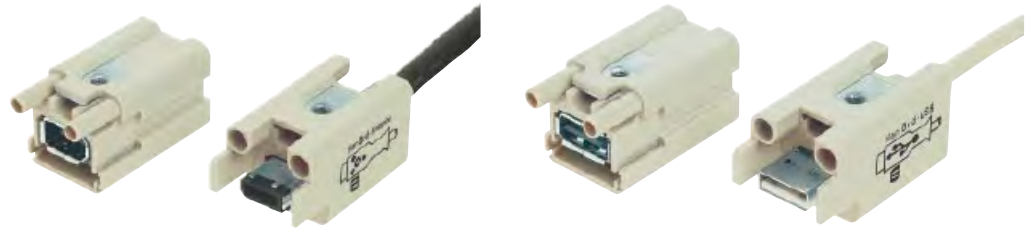
Firewire IEEE 1394

Specifications	DIN EN 60 664-1 DIN EN 61 984
Number of contacts	6
Electrical data acc. to EN 61 984	<b>1 A 50 V 0.8 kV 3</b>
Rated current	1 A
Rated voltage	50 V
Rated impulse voltage	0.8 kV
Pollution degree	3
Material	polycarbonate
Insulation resistance	≥ 10 <sup>10</sup> Ω
Contact resistance	≥ 4 mΩ
Temperature range	-40 °C ... +85 °C
Flammability acc. to UL 94	V 0
Mechanical working life - mating cycles	≥ 500

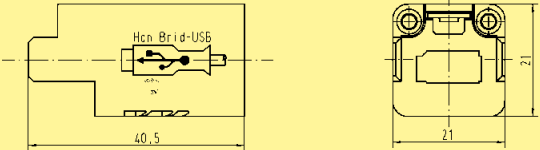
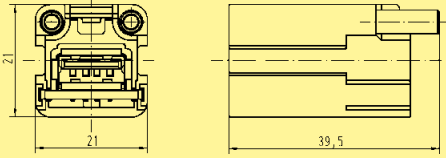

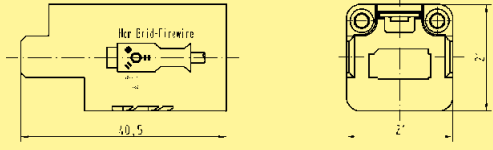
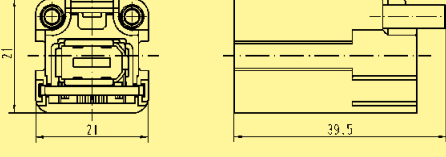
Identification	Part number		Drawing	Dimensions in mm
	Male insert (M)	Female insert (F)		
<p><b>Han-Brid® USB</b></p> <p>Cable side Female insert</p>  <p>Device side Male insert</p> 		<p><b>09 12 001 3091</b></p>	 	
<p><b>Han-Brid® FireWire</b></p> <p>Cable side Female insert</p>  <p>Device side Male insert</p> 		<p><b>09 12 001 3071</b></p>	 	

Han-Brid

## Features

- Suitable with housings, size Han® 3 A including versions Han® M, Han® EMV and Han® HPR
- Degree of protection up to IP 68
- For HARTING fibre optic SC contacts; up to 4 SC contacts per connector
- For 1 mm POF
- For Multimode fibre 50 - 62.5 / 125 µm and Single-mode fibre 9 / 125 µm
- Full ceramic sleeves for a minimal insertion loss

## Assembly instructions

## Male insert (09 20 004 4701)

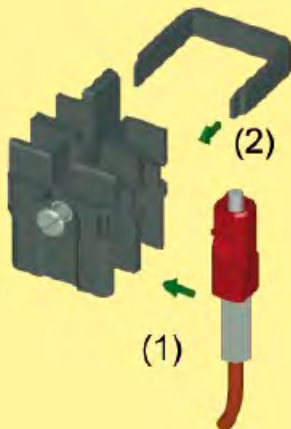

Assemble the SC contact

- (1) Push the SC contact from the side into the relevant insert
- (2) Push the spring clip over the contact body.

## Female insert (09 20 004 4711)

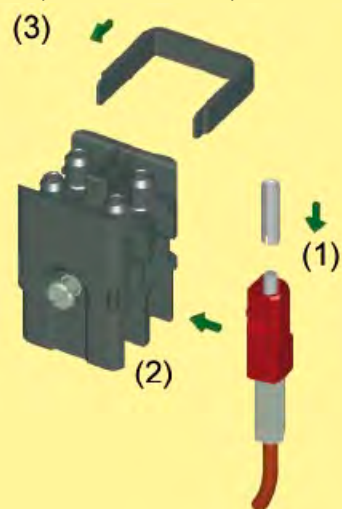

Assemble the SC contact

- (1) Push the centering ferrule (included in delivery) on the SC contact
- (2) Push the SC contact from the side into the relevant insert
- (3) Push the spring clip over the contact body.



Number of contacts

4

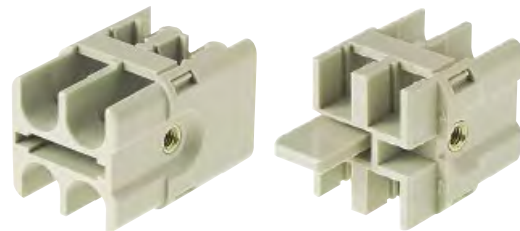

Identification	Part number		Drawing	Dimensions in mm
	Male insert (M)	Female insert (F)		
SC module Order SC contacts separately	<b>09 20 004 4701</b>	<b>09 20 004 4711</b>	<p>                     Contact arrangement view from termination side                      The female inserts are equipped with centering ferrules.                      4 ferrules are included in delivery range.                 </p>	

Identification	Part number		Drawing	Dimensions in mm
	Male contact	Female contact		
SC contact for GI fibre 50/125 µm or 62.5/125 µm ceramic ferrule 	<b>20 10 125 5211</b>	<b>20 10 125 5211</b>		Han-Brid
for Single mode fibre 9/125 µm	<b>20 10 125 5220</b>	<b>20 10 125 5220</b>		
for SI fibre (HCS®) 200/230 µm	20 10 230 5211	20 10 230 5211		
with quick assembly technique for 1 mm POF	<b>20 10 001 5217</b>	<b>20 10 001 5217</b>		
with crimp technique for 1 mm POF	<b>20 10 001 5211</b>	<b>20 10 001 5211</b>		

Stock items in bold type

## Han® 3 A Standard Hoods/Housings

### Metal hoods/housings for industrial applications

Material	zinc die-cast
Colour	RAL 7037 (grey)
Surface	powder-coated
Locking element	steel, zinc-plated
Lever type	lever, metal
Hoods/Housings sealing	NBR
Limiting temperatures	-40 °C ... +125 °C
Flammability acc. to UL 94	V 0
Degree of protection acc. to DIN EN 60 529 for coupled connector	IP 44 IP 67 is achieved with seal screw 09 20 000 9918

## Han® 3 A EMC Hoods/Housings

### Hoods/Housings for higher EMC requirements

Material	zinc die-cast
Colour	non coloured
Surface	electrical conductive
Locking element	steel, zinc-plated
Lever type	lever, metal
Hoods/Housings sealing	NBR
Limiting temperatures	-40 °C ... +125 °C
Degree of protection acc. to DIN EN 60 529 for coupled connector	IP 44 IP 67 is achieved with seal screw 09 20 000 9918

## Han® 3 A Hoods/Housings

### Plastic hoods/housings for industrial applications

Material	polycarbonate
Colour	RAL 7032 (light grey) RAL 9005 (black)
Locking element	Polyamide
Lever type	Lever, plastic
Hoods/Housings sealing	NBR
Limiting temperatures	-40 °C ... +125 °C
Approval acc. to UL 50	NEMA 4/12
Flammability acc. to UL 94	V 0
Degree of protection acc. to DIN EN 60 529 for coupled connector	IP 67

## Han-INOX® Hoods/Housings for higher corrosion requirements





Material	stainless steel
Colour	non coloured
Surface	electrical conductive
Locking element	Stainless steel
Lever type	lever, metal
Hoods/Housings sealing	NBR
Limiting temperatures	-40 °C ... +125 °C
Degree of protection acc. to DIN EN 60 529 for coupled connector	IP 65 IP 44 IP 67 is achieved with seal screw 09 20 000 9918
- Size Han® 3 A	

## Han® M Hoods/Housings

### Hoods/Housings for higher environmental requirements

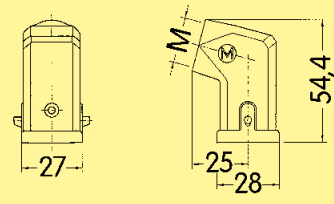
Material	aluminium die-cast
- Size Han® 3 A	zinc die-cast
Colour	RAL 9005 (black)
Surface	
- Top coat	Epoxy powder paint
Locking element	Stainless steel
Lever type	lever, metal
Hoods/Housings sealing	FPM
Limiting temperatures	-40 °C ... +125 °C
Approval acc. to UL 50	NEMA 4/12
Degree of protection acc. to DIN EN 60 529 for coupled connector	IP 65 IP 44 IP 67 is achieved with seal screw 09 20 000 9918
- Size Han® 3 A	

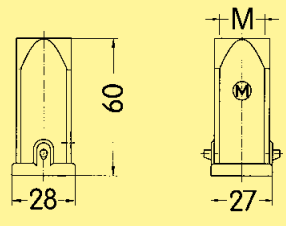
Metal hoods/housings for industrial applications / 1 lever locking system with sealing

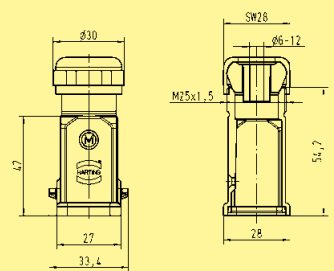
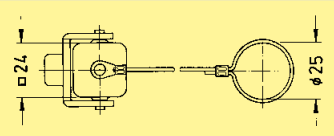
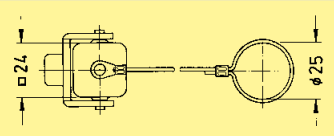
Identification	Part number	Cable entry metric	Drawing	Dimensions in mm
Hoods side entry 	<b>19 20 003 1643</b>	M 20		54,4 27 25 28
Hoods top entry 	<b>19 20 003 1443</b>	M 20		60 28 27
Hoods top entry 	6 ... 12 mm <b>19 20 003 1423</b>			830 67 27 33,4 SW28 86-12 M2,5x1,5 5,7 28
Protection covers for hoods 	<b>09 20 003 5422</b>			24 25

Metal hoods/housings for industrial applications / 1 lever locking system

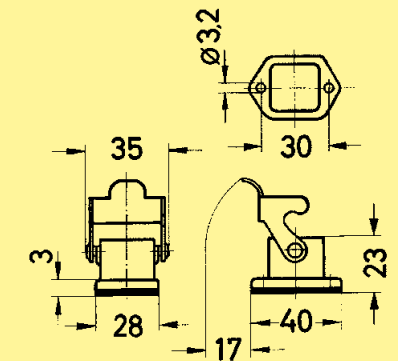





Identification	Part number	Cable entry metric	Drawing	Dimensions in mm
Housings, bulkhead mounting 	<b>09 20 003 0301</b>			35 30 3 28 17 40 23 32 3

Panel cut out 22 x 22 mm

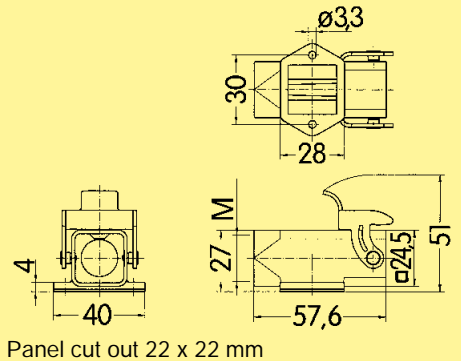
Stock items in bold type

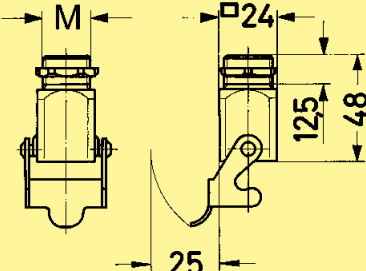

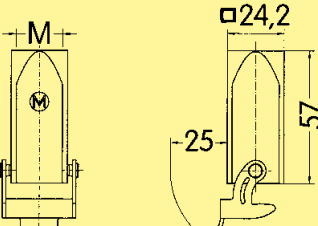
Han-Brid

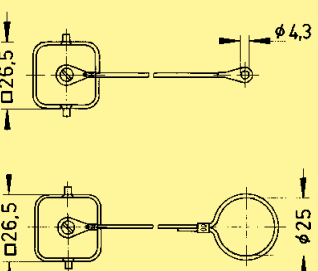
Metal hoods/housings for industrial applications / 1 lever locking system

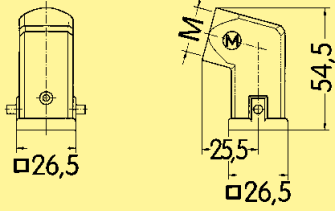

Identification	Part number	Cable entry metric	Drawing	Dimensions in mm
Housings, surface mounting side entry 	<b>19 20 003 1250</b>  bottom closed <b>19 20 003 1252</b>	M 20  M 20	 <p>Panel cut out 22 x 22 mm</p>	
Housings, screw mounting top entry 	<b>19 20 003 1150</b>	M 20		
Hoods, cable to cable top entry 	<b>19 20 003 1750</b>	M 20		
Protection covers 	<b>09 20 003 5425</b>  <b>09 20 003 5427</b>			

Han-Brid

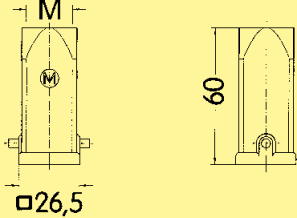
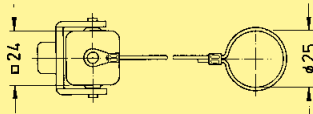
Plastic hoods/housings for industrial applications / 1 lever locking system with sealing



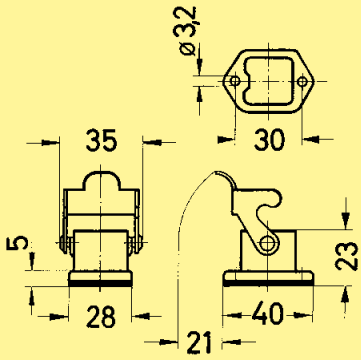

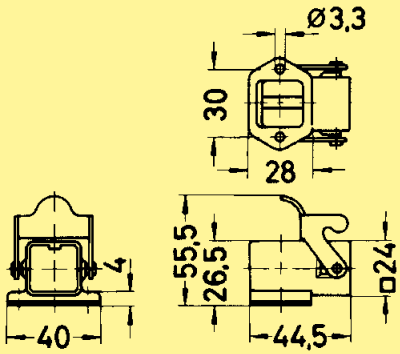

Identification	Part number	Cable entry metric	Drawing	Dimensions in mm
Hoods side entry 	light grey <b>19 20 003 0623</b> black 19 20 003 0626	M 20 M 20		
Hoods top entry 	light grey 19 20 003 0423 black <b>19 20 003 0426</b>	M 20 M 20		
Protection covers for hoods	light grey 09 20 003 5442			

Plastic hoods/housings for industrial applications / 1 lever locking system

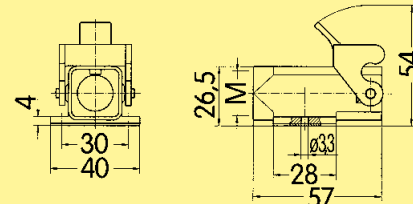
Identification	Part number	Cable entry metric	Drawing	Dimensions in mm
Housings, bulkhead mounting 	light grey <b>09 20 003 0320</b> black <b>09 20 003 0327</b>			
	light grey <b>09 20 003 0820</b> black 09 20 003 0827			

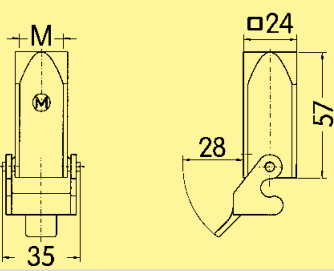
Han-Brid

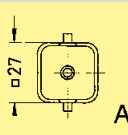

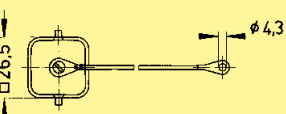
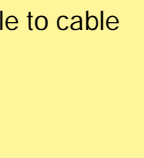
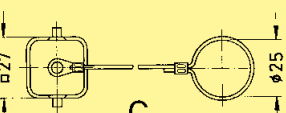
Plastic hoods/housings for industrial applications / 1 lever locking system

Identification	Part number	Cable entry metric	Drawing	Dimensions in mm
Housings, surface mounting side entry 	light grey <b>19 20 003 0220</b> black 19 20 003 0227	M 20 M 20		Panel cut out 22 x 22 mm
Hoods, cable to cable top entry 	light grey <b>19 20 003 0720</b> black <b>19 20 003 0727</b>	M 20 M 20		
Protection covers 	light grey <b>09 20 003 5408<sup>2)</sup></b> black <b>09 20 003 5409<sup>2)</sup></b>			
Protection covers for housings 	light grey <b>09 20 003 5445<sup>2)</sup></b> black <b>09 20 003 5449<sup>2)</sup></b>			
Protection covers for hoods cable to cable 	light grey <b>09 20 003 5447<sup>1)2)</sup></b>			



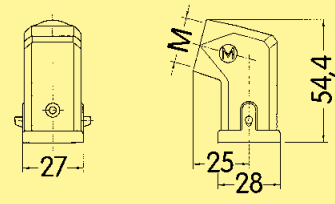

Han-Brid

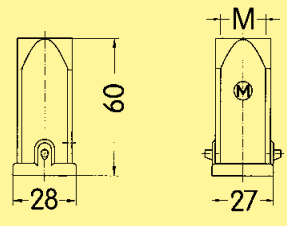
<sup>1)</sup> for metal housings and cable to cable hoods also  
<sup>2)</sup> for mounted female insert or for mounted Han-Brid® insert

Hoods/Housings for higher EMC requirements / 1 lever locking system with sealing

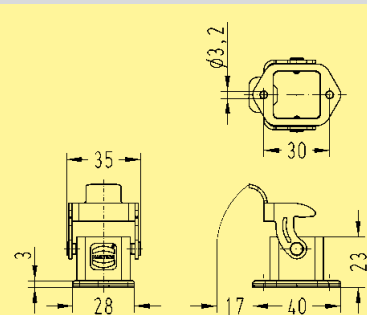

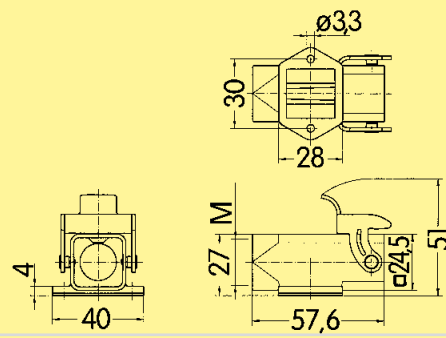
Identification	Part number	Cable entry metric	Drawing	Dimensions in mm
Hoods side entry 	19 62 003 1643	M 20		
Hoods top entry 	19 62 003 1443	M 20		

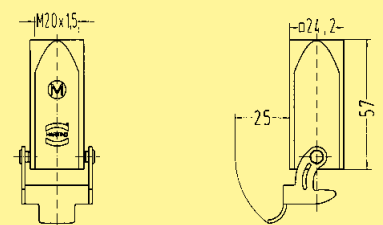
Hoods/Housings for higher EMC requirements / 1 lever locking system



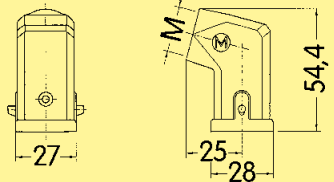

Identification	Part number	Cable entry metric	Drawing	Dimensions in mm
Housings, bulkhead mounting 	<b>09 62 003 0301</b>			
Housings, surface mounting top entry 	19 62 003 1250	M 20		
Hoods, cable to cable top entry 	19 62 003 1750	M 20		

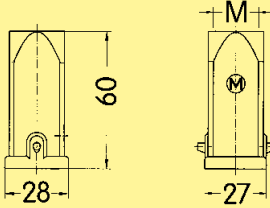
Han-Brid

Hoods/Housings for higher environmental requirements / 1 lever locking system with sealing

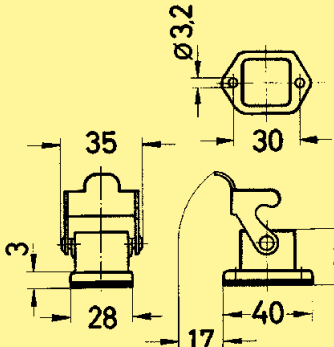
Identification	Part number	Cable entry metric	Drawing	Dimensions in mm
Hoods side entry 	19 37 003 1643	M 20		
Hoods top entry 	19 37 003 1443	M 20		

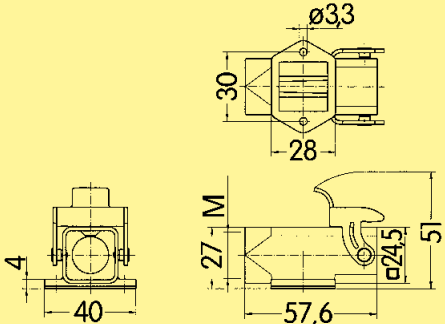
Hoods/Housings for higher environmental requirements / 1 lever locking system

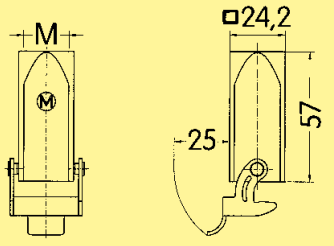
Identification	Part number	Cable entry metric	Drawing	Dimensions in mm
Housings, bulkhead mounting top entry 	09 37 003 0301			
Housings, surface mounting top entry 	19 37 003 1250	M 20		
Hoods, cable to cable top entry 	19 37 003 1750	M 20		

Han-Brid



Hoods/Housings made of stainless steel / 1 lever locking system with sealing

Identification	Part number	Cable entry metric	Drawing	Dimensions in mm
Hoods top entry	<b>19 44 003 1443</b>	M 20		

Hoods/Housings made of stainless steel / 1 lever locking system

Identification	Part number	Cable entry metric	Drawing	Dimensions in mm
Housings, bulkhead mounting	<b>19 44 003 0301</b>			Panel cut out 22 x 22 mm

Cable gland	<b>19 44 000 5082</b>	M 20		
-------------	-----------------------	------	--	--

Han-Brid

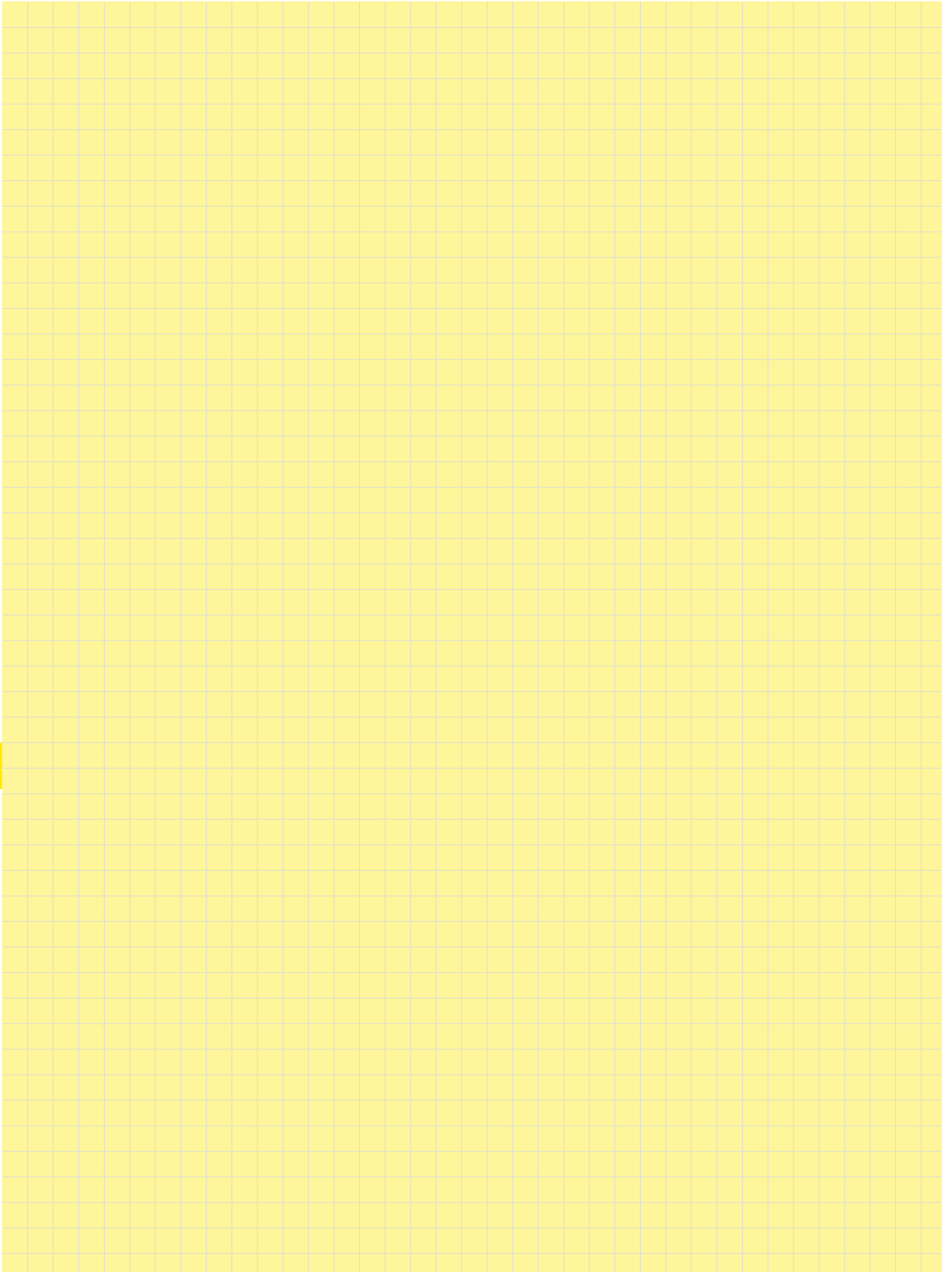

Han-  
Brid